

Audio wiring of MX Console & Installation Frames 52-4xxxC including 52-4592A Microphone XLR Plate or 52-4592B Mic/Headphone Plate 52-4527B Loudspeaker/Control Module or 52-4424B Loudspeaker/Control Module, large

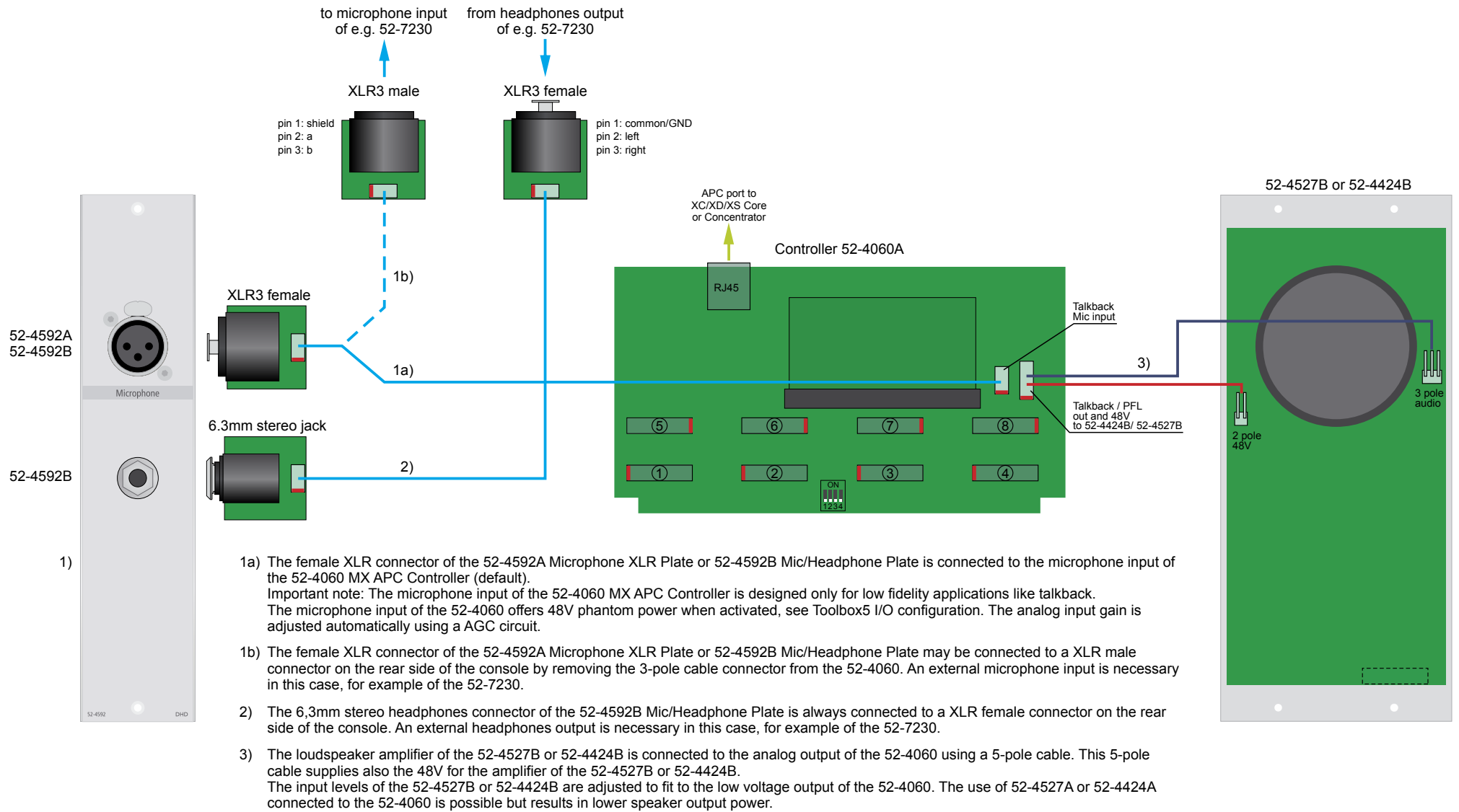

Specifications and design are subject to change without notice.

The content of this document is for information only. The information presented in this document does not form part of any quotation or contract, is believed to be accurate and reliable and may be changed without notice. No liability will be accepted by the publisher for any consequence of its use. Publication thereof does neither convey nor imply any license under patent- or other industrial or intellectual property rights.