

Cutout for Console Frame of Mixing Console 52/MX.
For dimensions of Console Frame, see next page!

 <p>DHD Deubner Hoffmann Digital GmbH Hafenkornstrasse 5 04129 Leipzig / Germany Phone: +49 341 5897020 Fax: +49 341 5897022 E-mail: dhd@dhd-audio.com Internet: www.dhd-audio.com</p>	Scale: 1:5 (DIN A4)		
	Dimensions cutout for Console Frame of Mixing Consoles 52/MX		
Name: Miethling	52-4824		Page:
Date: 03.01.2011			1/2
File: 52-4824_dimension.dwg			

view X, scale 1:2

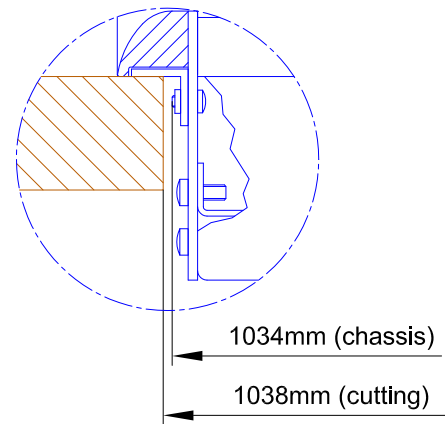

cut A - A

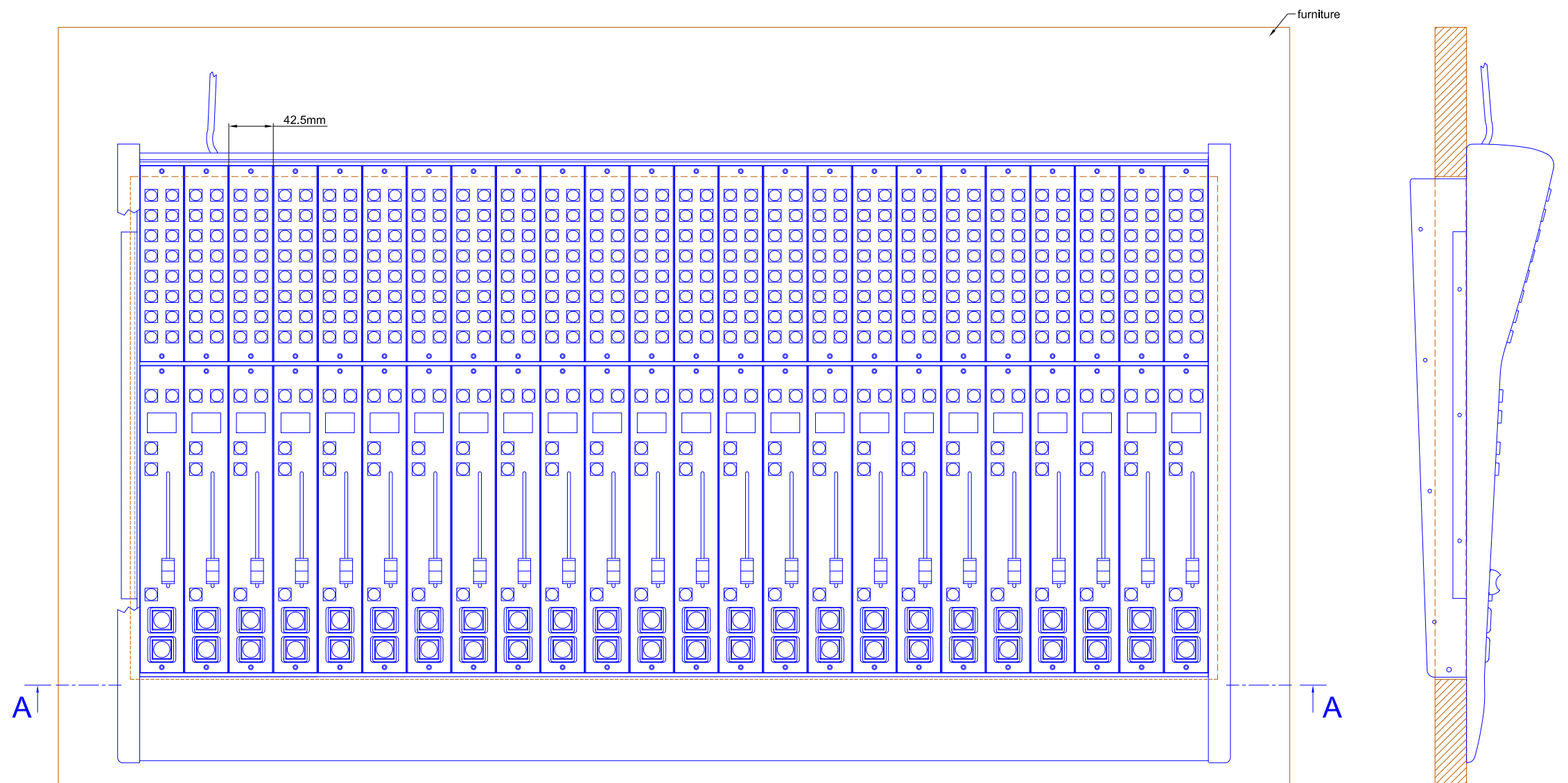
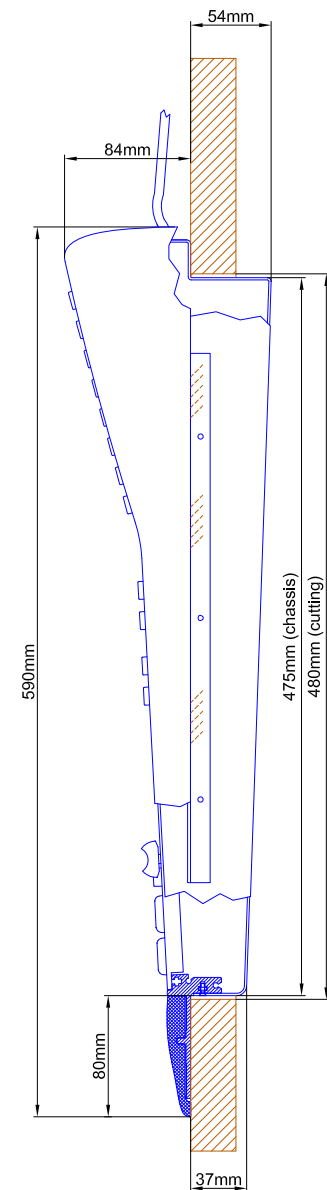
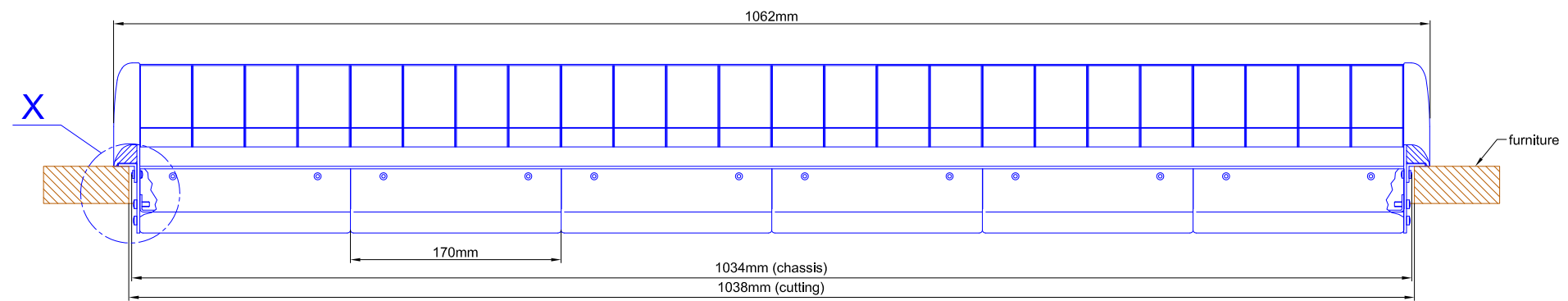

Specifications and design are subject to change without notice. The content of this document is for information only. The information presented in this document does not form part of any quotation or contract, is believed to be accurate and reliable and may be changed without notice. No liability will be accepted by the publisher for any consequence of its use. Publication thereof does neither convey nor imply any license under patent- or other industrial or intellectual property rights.

 <p>DHD Deubner Hoffmann Digital GmbH Haferkornstrasse 5 04129 Leipzig / Germany Phone: +49 341 5897020 Fax: +49 341 5897022 E-mail: dhd@dhd-audio.com Internet: www.dhd-audio.com</p>	Scale: 1:5 (DIN A3)		
	<p>Dimension 52/MX L/S-size Console Frame 24 positions, L-size 293x42.5mm/ S-size 193x42.5mm</p>		
Name: Miethling	52-4824		Page:
Date: 03.02.2011			2/2
File: 52-4824_dimension.dwg			