

Cutout for Console Frame of Mixing Console 52/MX.
For dimensions of Console Frame, see next page!



DHD
Deubner Hoffmann Digital GmbH
Haferkomstrasse 5
04129 Leipzig / Germany
Phone: +49 341 5897020
Fax: +49 341 5897022
E-mail: dhd@dhd-audio.com
Internet: www.dhd-audio.com

Dimensions cutout for Console Frame of Mixing Consoles 52/MX

Name: Miethling

Date: 11.08.2015

File: 52-4812d_dimension.dwg

52-4812D

Page:

1/2

view X, scale 1:2

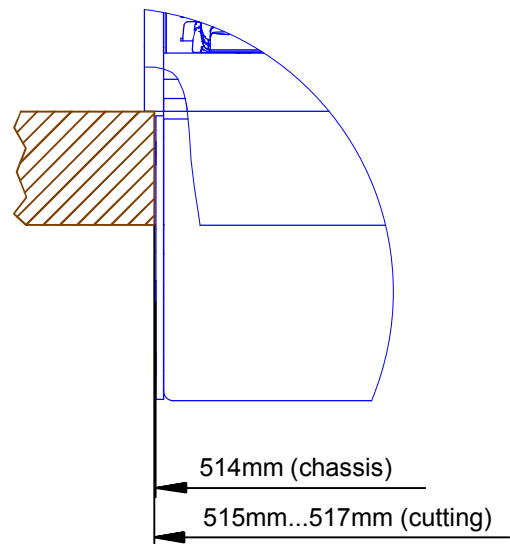

cut A - A

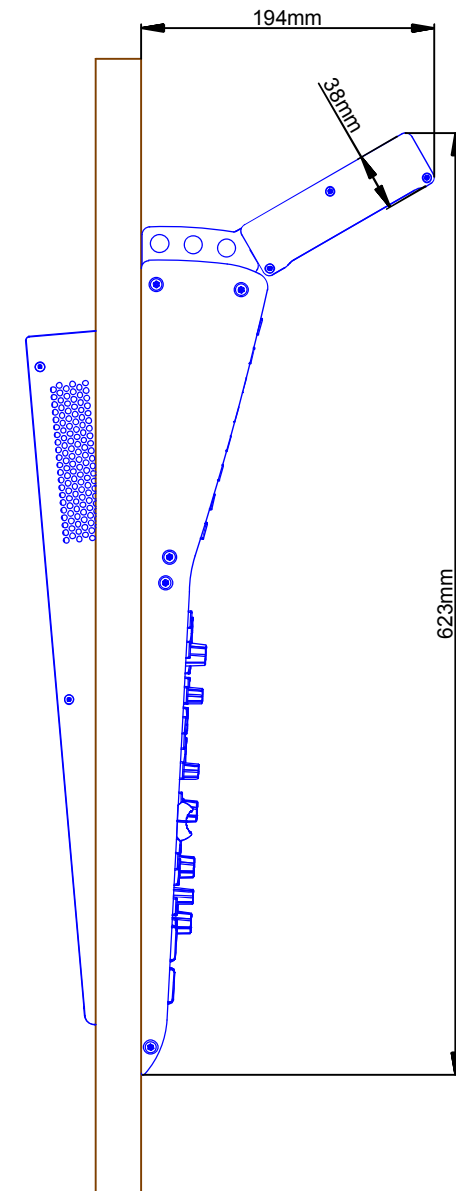
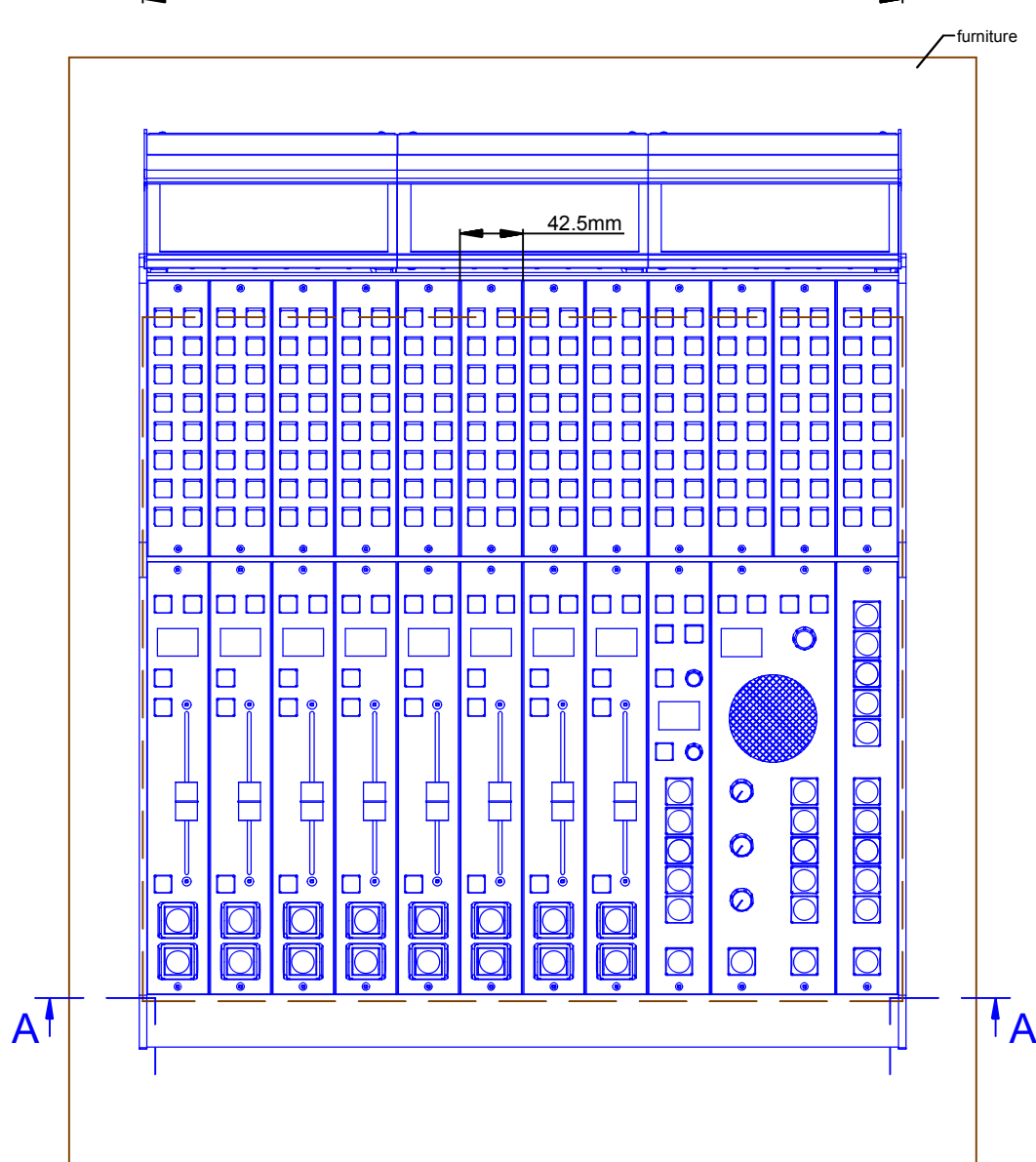
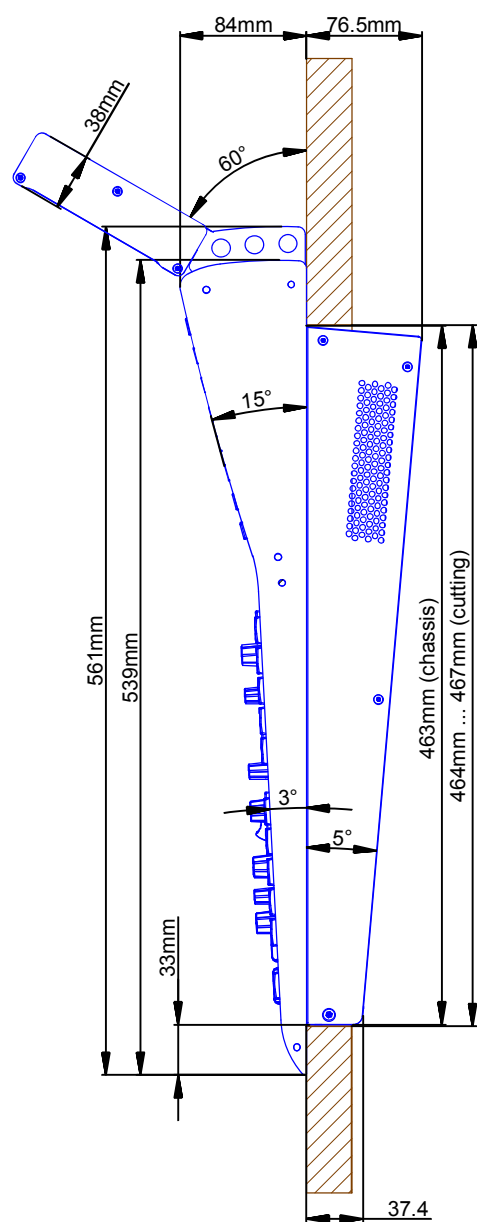
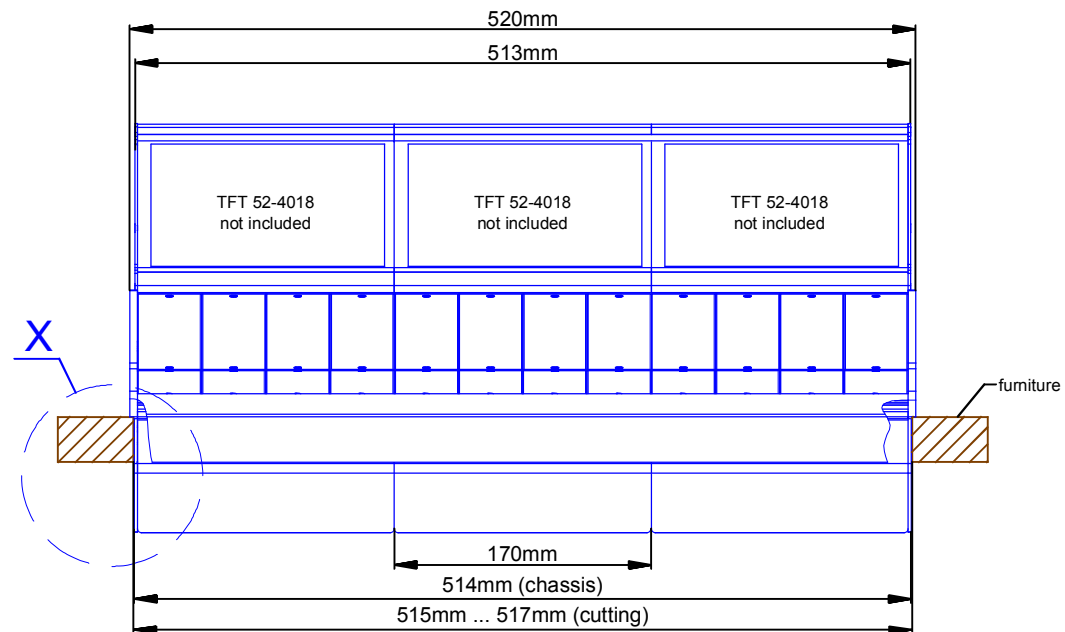

Specifications and design are subject to change without notice. The content of this document is for information only. The information presented in this document does not form part of any quotation or contract, is believed to be accurate and reliable and may be changed without notice. No liability will be accepted by the publisher for any consequence of its use. Publication thereof does neither convey nor imply any license under patent- or other industrial or intellectual property rights.

DHD
Deubner Hoffmann Digital GmbH
Haferkornstrasse 5
04129 Leipzig / Germany
Phone: +49 341 5897020
Fax: +49 341 5897022
E-mail: dhd@dhd-audio.com
Internet: www.dhd-audio.com

Scale: 1:5 (DIN A3)

Dimensions 52/MX L/S-size Console Frame with metal side panels
12 positions, L-size 293x42.5mm/ S-size 193x42.5mm

Name: Miethling
Date: 11.08.2015
File: 52-4812d_dimension.dwg

52-4812D

Page:
2/2