

View X (scale 1:2)

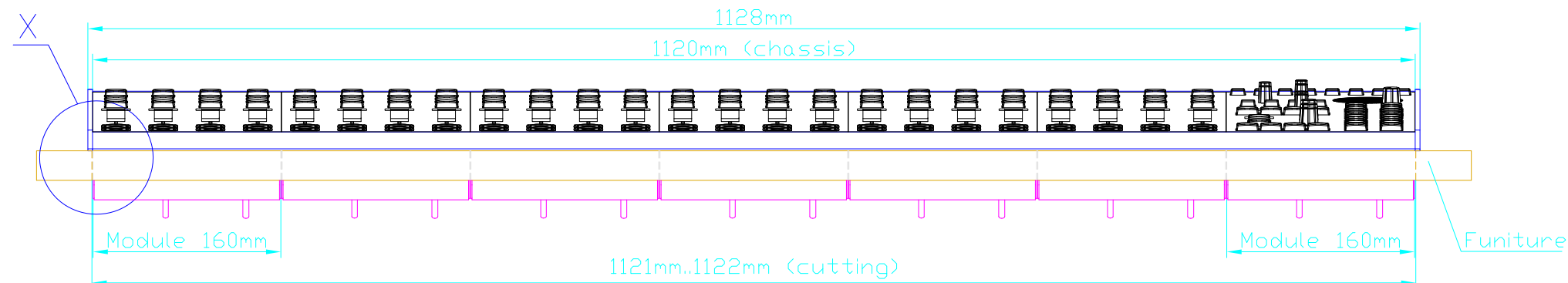

Cut A-A

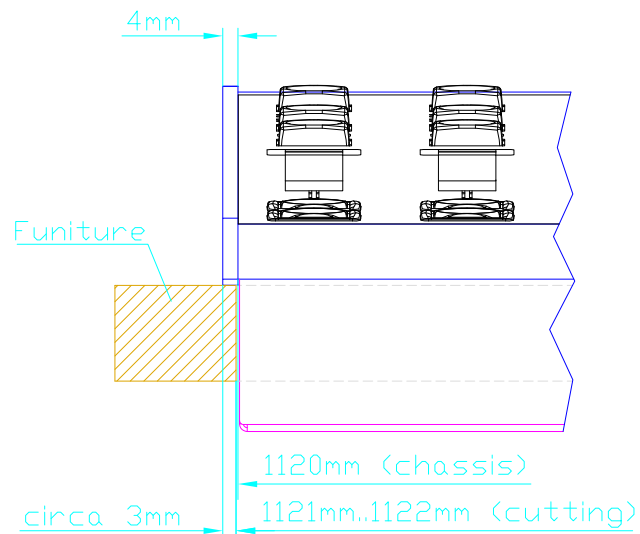
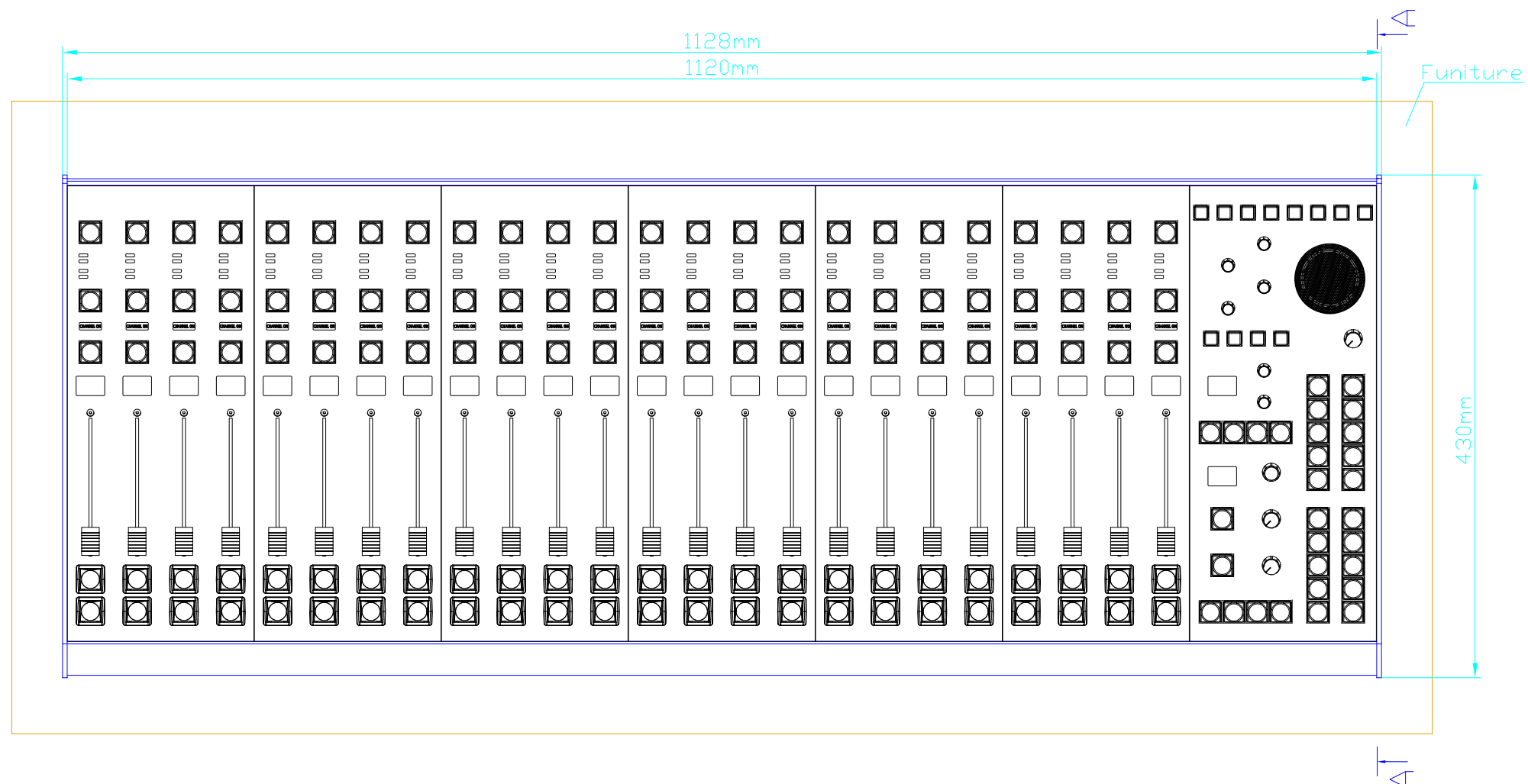
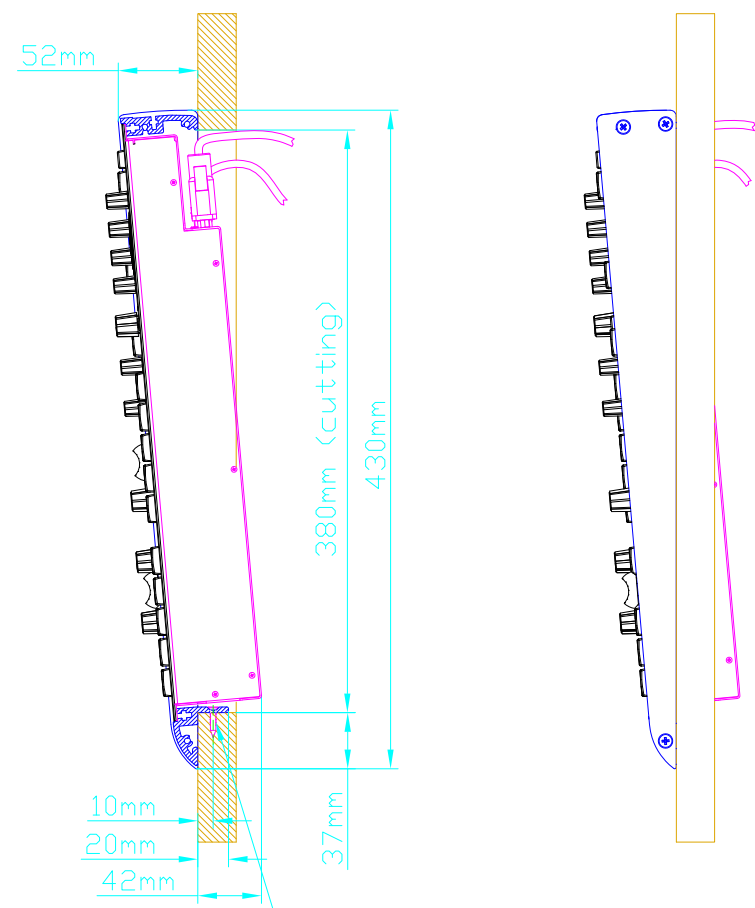

For fixing console frame to furniture, please drill bore d=3,5...4mm into aluminium profile for wooden screw.

Specifications and design are subject to change without notice. The content of this document is for information only. The information presented in this document does not form part of any quotation or contract, is believed to be accurate and reliable and may be changed without notice. No liability will be accepted by the publisher for any consequence of its use. Publication thereof does neither convey nor imply any license under patent- or other industrial or intellectual property rights.

Console Frame for example Mixing Console 52/RX

 <p>DHD Deubner Hoffmann Digital GmbH Haferkornstrasse 5 04129 Leipzig / Germany Phone: +49 341 5897020 Fax: +49 341 5897022 E-mail: dhd@dhd-audio.com Internet: www.dhd-audio.com</p>	Scale: 1:5 (DIN A3)	<p>Dimensions Console Frame of Mixing Console 52/RX</p>	
	<p>Name: Miethling Date: 08.06.2010 File: 52-2828_dimension.dwg</p>		